

# DHI-ARD1233-W2(868)

## Wireless PIR detector



- Pet immunity function.
- Auto temperature compensation.
- 3-level sensitivity adjustment.
- Signal strength detection.
- Low battery alarm.
- Temperature measurement.
- Frequency hopping function and two-way communication technology ensure communication stability.
- Cloud update and automatic recovery from update failure.

### System Overview

Wireless PIR detector is a wireless motion detector that can detect if there is a human moving around the detector. It can detect human or large animals invading the armed area, and provides timely notifications of alarm events, acting as a monitoring mechanism.

### Scene

Mainly applied for villas, shops, apartments, etc.

### Technical Specification

#### Port

Indicator Light	1 × green alarm indicator
Button	1 × power button

#### Function

Tamper Alarm	Yes
Remote Upgrade	Cloud update
Search	Signal strength detection
Test Mode	Yes
Low Battery Alarm	Yes

#### Wireless

Carrier Frequency	868.0 MHz–868.6 MHz
Communication Distance	Up to 1,600 m (5,249.34 ft) in an open space
Communication Mechanism	Two-way
Encryption Mode	AES128

Frequency Hopping	Yes
-------------------	-----

#### General

Power Supply	CR123A battery
Power Consumption	Max. 120 mW
Operating Temperature	−10 °C to +55 °C (+14 °F to +131 °F) (indoor)
Operating Humidity	10%–90% (RH).
Dimensions	104.0 mm × 60.0 mm × 50.0 mm (4.09" × 2.36" × 1.97") (L × W × H)
Package Dimensions	135.0 mm × 98.5 mm × 56.8 mm (5.31" × 3.88" × 2.24") (L × W × H)
Installation Mode	Wall mount
Net Weight	100 g (0.22 lb)
Gross Weight	170 g (0.37 lb)
Certifications	CE
Battery Life	4 years
Casing	PC + ABS

#### Temperature

Measuring Range	−15 °C to +65 °C (+18.8 °F to +149 °F) (indoor)
Measuring Precision	± 1 °C (± 33.8 °F)
Resolution	1 °C (33.8 °F)

#### Specification

Detection Mode	PIR
Sensor	Dual-element low-noise PIR sensor

Detection Range	12 m (39.37 ft) (90°) with installation height of 2.2 m (7.21 ft)
Detection Speed	0.3 m/s–3 m/s (0.98 ft/s–9.84 ft/s)
Pet Immunity Level	≤ 18 kg (39.68 lb)
White Light Resistance Level	6500 lx
Two-way Digital Temperature Compensation	Yes, no attenuation of detection distance in high temperature
Sensitivity	3 levels adjustable

## Ordering Information

Type	Part Number	Description
Wireless PIR detector	DHI-ARD1233-W2(868)	Wireless PIR detector

## Installation

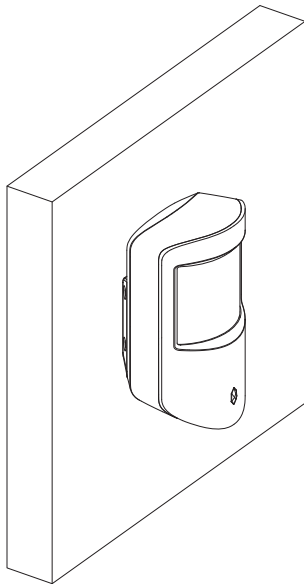

## Dimensions (mm[inch])

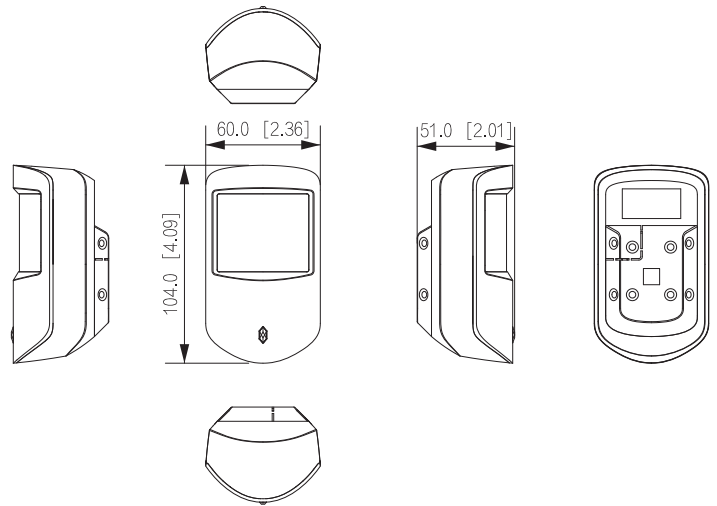

## Application

