

VANDERBILT

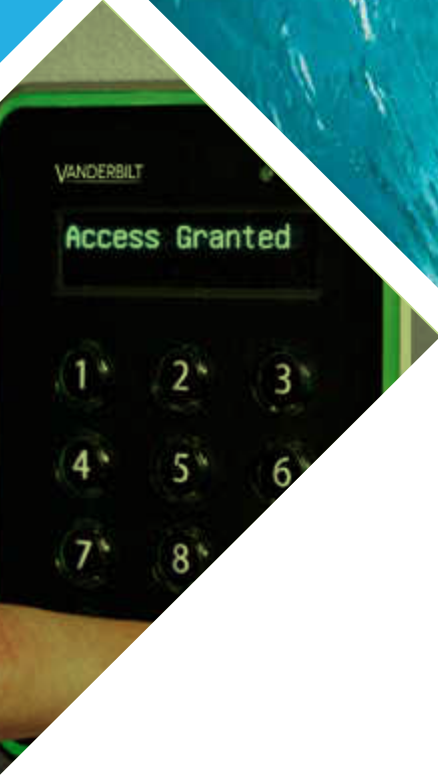

Vanderbilt Product Portfolio

Ready for any challenge

vanderbiltindustries.com

ACCESS CONTROL PORTFOLIO

Vanderbilt is developing access control to be far more than regulation of who goes where and when. We now offer tools that not only prevent threats from intruders but safeguard your staff while producing valuable business intelligence.

Readers, Cards and Tag

Vanderbilt provides a wide range of readers and cards to satisfy the access control requirements of most environments. Our readers and cards can work with virtually any access control system on the market. Vanderbilt reader technologies include: Smart Card 13.56 MHz, Cotag, Proximity 125 kHz and Magnetic Stripe.



Networked Access Control

Vanderbilt's portfolio of network based access control systems delivers integration with video management and workforce management applications. Our networked based systems include ACTpro, Entro and Aliro – all of which offer tailored solutions for specific user requirements.



Single Door Products

Vanderbilt single door products include digital keypads and audio entry systems suitable for commercial and residential uses. All products combine reliability, contemporary design and are easy to install and operate.

Controllers, Door Controllers and Input/Output Modules

Vanderbilt's range of controllers include:

- ✔ Single, two & four door IP options with onboard PSUs
- ✔ Add-on door stations for system expansions
- ✔ Advanced central controllers for enterprise systems
- ✔ Input/output modules for third party cause & effect
- ✔ Reservation terminal for local bookings

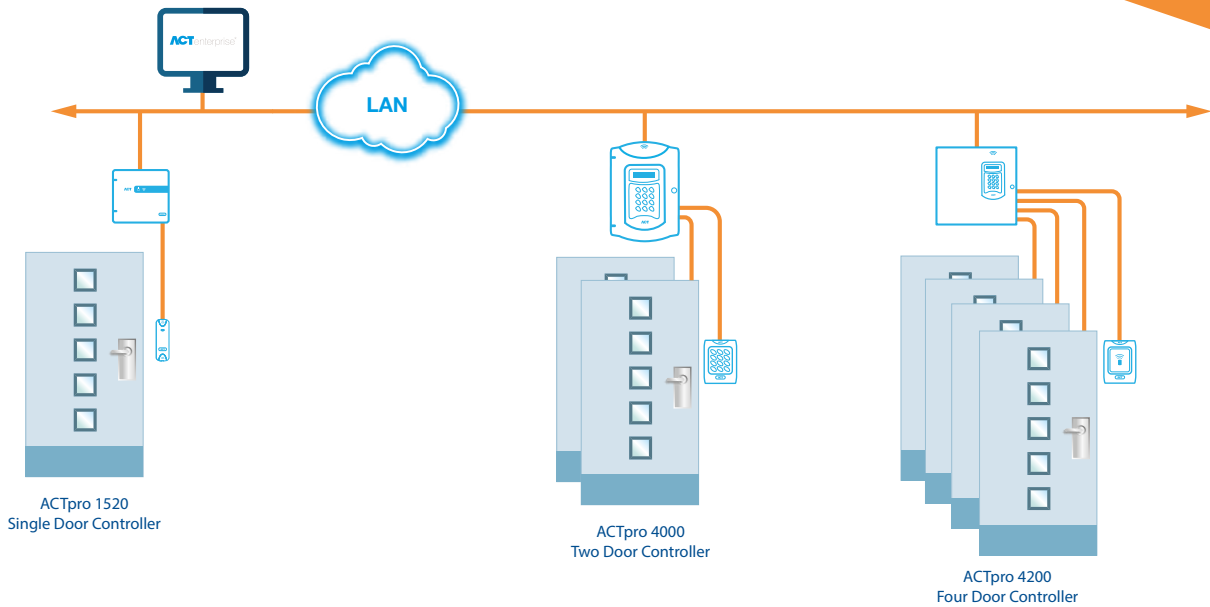

Advanced Access Control

SiPass® integrated is our powerful, scalable and very flexible access control system that provides a high level of security without compromising convenience. SiPass can be used to integrate access control, intrusion detection and video surveillance into a single interoperable system.

Interoperable Security Systems

Electronic security systems from Vanderbilt have inherent interoperability capability, meaning that regardless of the system size, the components can interact on the controller level without the need of a central management system. The Vanderbilt offering is in principle “plug and play” directly out of the box.

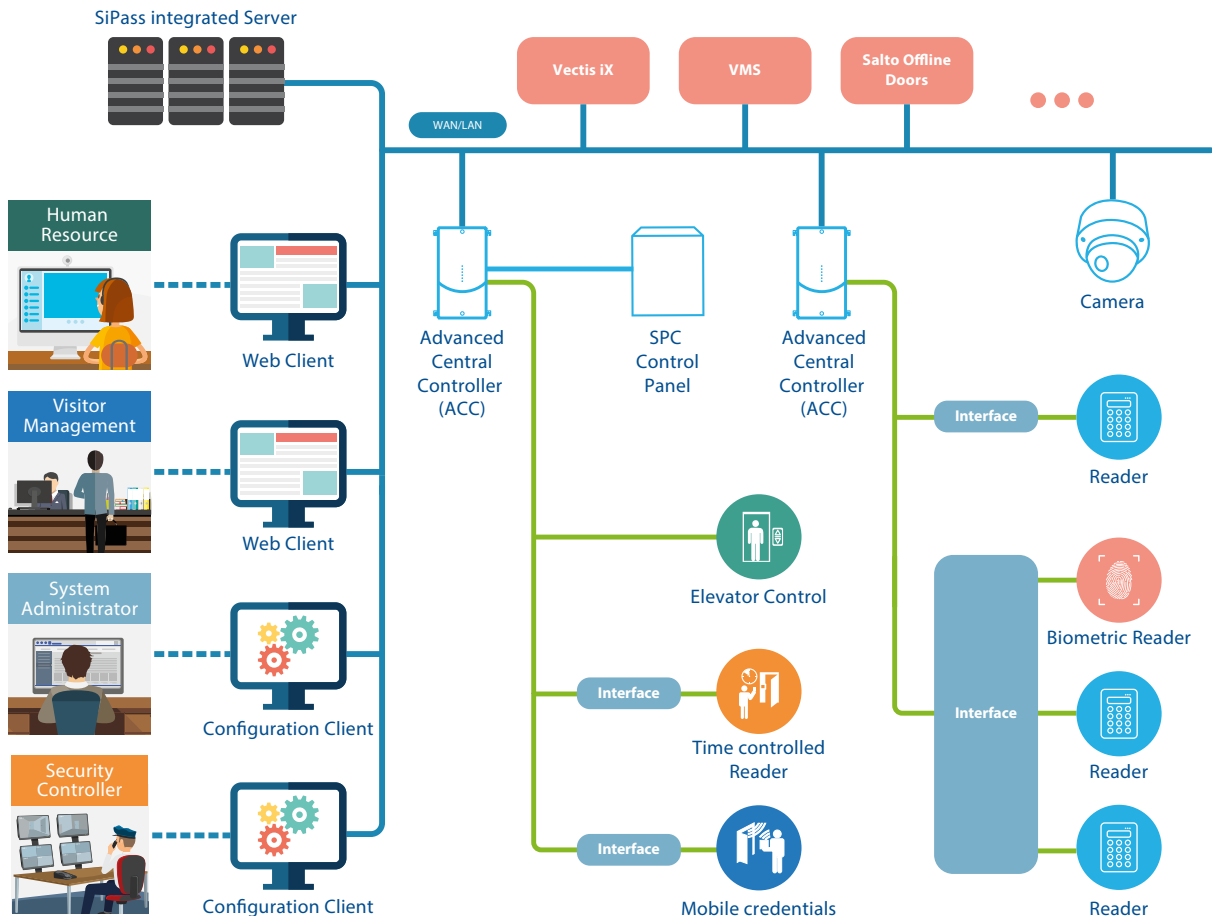

INTRUSION DETECTION PORTFOLIO

Vanderbilt's intrusion solutions span many sectors with some of the most reliable security products on the market today. Our intrusion range includes a cloud based management tool that allow you to remotely access and manage your system wherever and whenever you need to.

Motion, infrared and seismic detectors offer a comprehensive protection solution. Our solutions are ideal for areas such as domestic security, financial security, commercial security, retail security, cloud enabled technologies, and vault protection.

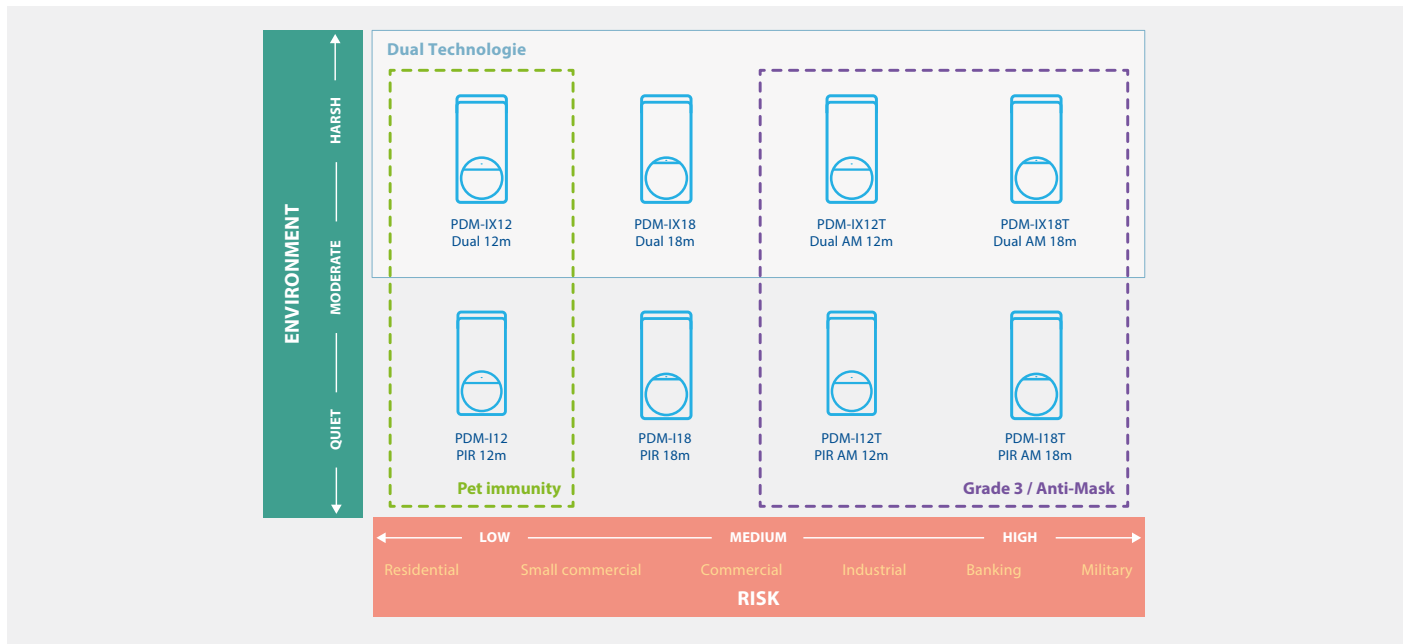

Seismic Detectors

Vanderbilt seismic detectors are specifically designed for round-the-clock monitoring of safes, ATMs, night deposits, strong rooms and modular vaults and protection against vandalism and theft. Easy to install and program, Vanderbilt seismic detectors offer one of the highest detection range and false alarm immunity on the market.

Motion Detectors

Vanderbilt single and dual technology motion detectors are designed to deliver the highest false alarm immunity. With a modern design allowing for a quick and clean installation, all motion detectors are tamper-proof and provide highly reliable detection in all applications and environments.

Glass Break Detectors

Vanderbilt glass break detectors are ideal for monitoring one or more areas of glass. Developed with the latest microprocessor technology, which incorporates advanced algorithms monitoring the room acoustics (Digital Room Compensation, DRC), these algorithms reliably distinguish between glass breaking and other internal noises to eradicate false alarms.



SPC Series

Vanderbilt single and dual technology motion SPC is a professional intrusion detection system that offers versatile and comprehensive alarm management functionality. Through the use of cloud services, end user apps and a dedicated software suite, SPC is at the forefront of modern intrusion detection that can easily be adapted to changing requirements, offering wired or wireless options.



SPC offers many compelling business advantages to installers:

- ✓ Adaptable - from small to large, simple to complex
- ✓ Stylish - beautifully designed with aesthetics customers enjoy
- ✓ Secure - created to ensure you and your customers are protected, always
- ✓ Connected – built on a powerful communications platform which caters for all functions including maintenance and remote configuration
- ✓ Ready – flexible control that has been built to meet the most demanding requirements and situations

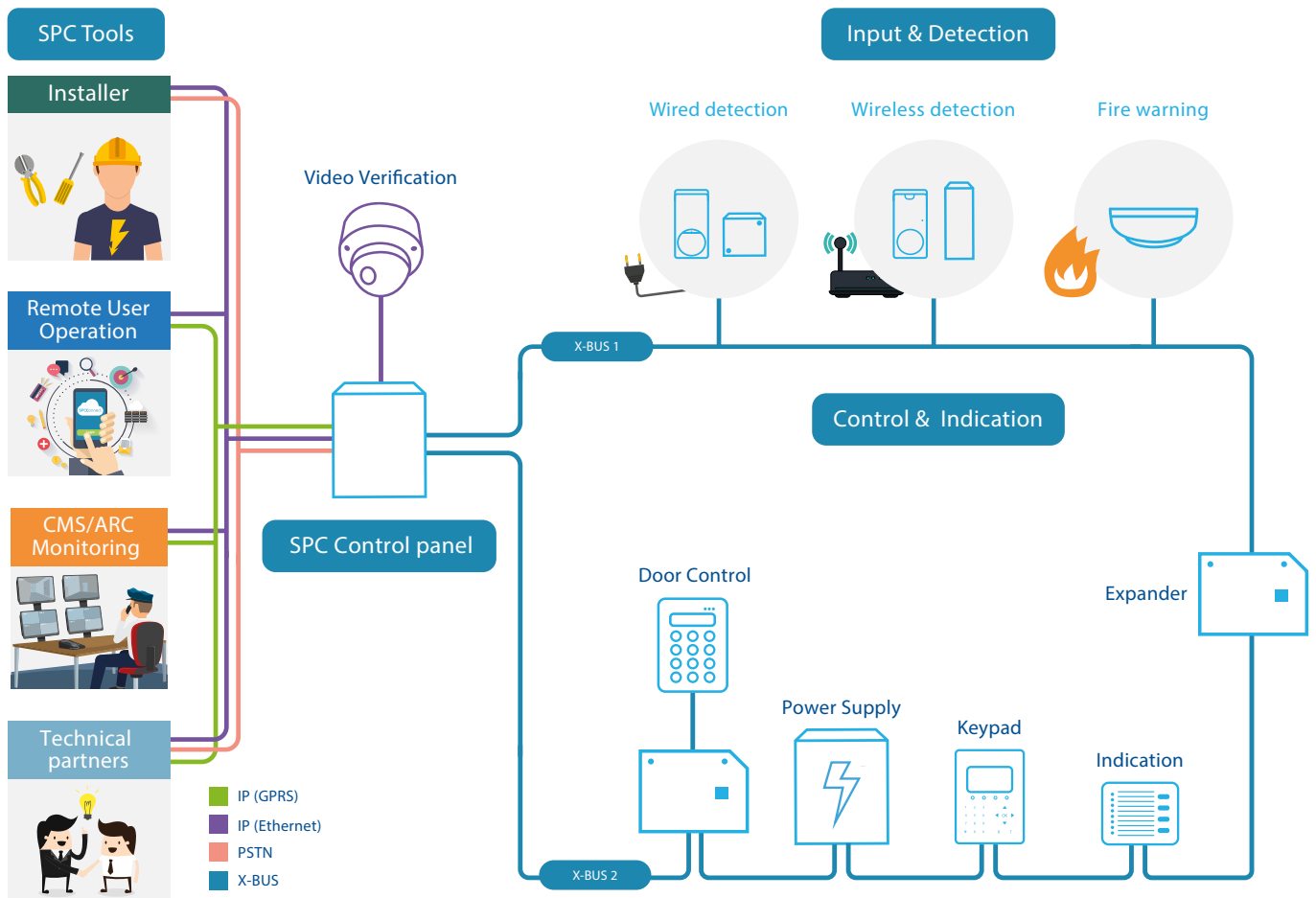

VIDEO SURVEILLANCE PORTFOLIO

Vanderbilt video products can detect, record, analyze and deter threats to your personnel and premises. Our product offering can grow with customers from basic analog cameras to IP systems as part of an evolving integrated security management solution.



The array of products empowers you to make optimum decisions based on the best possible enterprise-wide data. Whether your requirement is dome, bullet, fixed, PTZ cameras or a mix, we'll combine surveillance with rapid retrieval, analytics and export all from a best-of-breed Video Management System.



Eventys Video Surveillance

Eventys is the perfect range of video surveillance equipment for applications that require cost-effective, easy to set up systems from a supplier that delivers end-to-end security solutions and superior customer services.

Vectis iX Video Surveillance

Vectis iX is Vanderbilt's professional range of video surveillance that supports IP cameras up to 20MP. Combined with Vanderbilt's professional range of cameras Vectis iX is scalable, making it suited for many types of applications from small to complex, high-security multi-site environments when working with a CMS.



CLOUD PORTFOLIO

ACT365

ACT365 is a complete cloud-based access control and video management solution. With access to all your sites from one online interface, you can provide remote maintenance from anywhere, at any time.

ACT365's software is dedicated to a simple mantra - adaptability and flexibility. Miles on the road eat up time. ACT365 technology helps ease this situation.



ACT365's features put the customer first. They eradicate once burdensome responsibilities that can now be promptly completed through the click of a button on mobile or desktop devices. Through the power of remote monitoring available from ACT365, Vanderbilt offers both installers and end-users convenience through simplicity.



Benefits at a glance:

- ✔ Installer portal and app enable remote management of multiple customers and sites from a single interface
- ✔ Remote diagnostics and servicing on voltage, mains, PSU, etc.
- ✔ No Software to install
- ✔ API for simple integrations with third party software
- ✔ Recurring revenue opportunities





SPC Connect

SPC Connect is the Vanderbilt hosted cloud-based management tool empowering your SPC system on the cloud. For system users SPC connect offers a powerful secure interface for all their needs, including setting and unsetting alarms and viewing live cameras on the system. For installers it enables you to manage your customer's tasks remotely'. By removing the physical need to visit a site, it delivers you control while saving you time and money.

Benefits at a glance:

- ✔ Complete remote programming of SPC systems
- ✔ "Always on" communication allowing for instant access
- ✔ Organization structure to support business workflow
- ✔ Definable roles and responsibilities

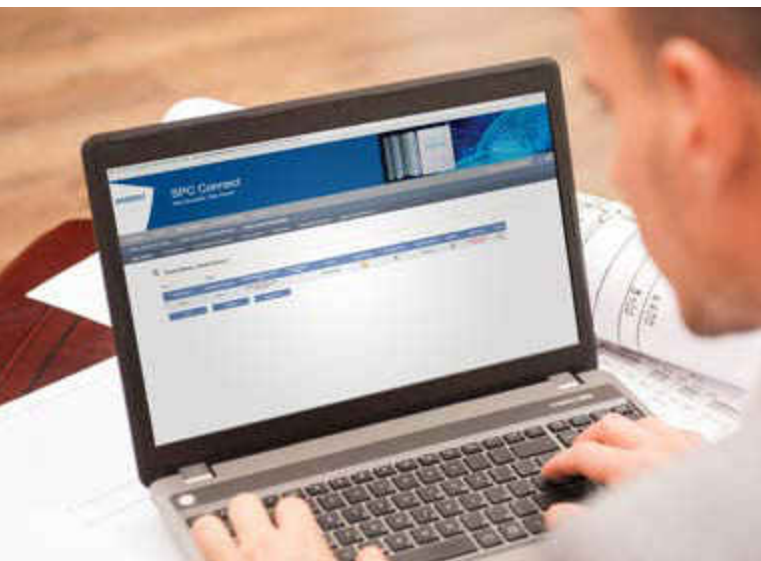
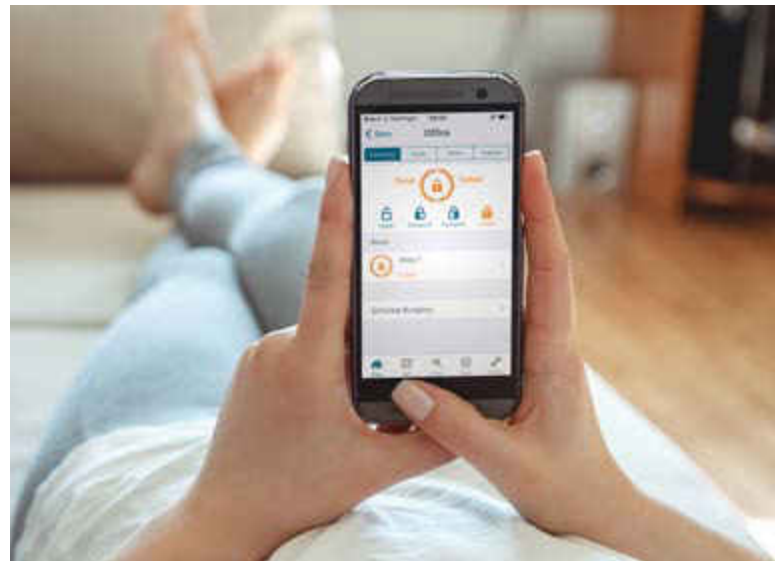

- ✔ Installer support services
- ✔ Monitoring communications
- ✔ Maintenance reports
- ✔ Configuration file maintenance
- ✔ No IT server maintenance cost for vanderbiltindustries.com/spc-connect solution
- ✔ Access remotely from any PC, phone or tablet

VANDERBILT

vanderbiltindustries.com

@VanderbiltInd

Vanderbilt Industries

Vanderbilt International Ltd.

Clonshaugh Business and Technology Park
Clonshaugh, Dublin, D17 KV 84, Ireland

+353 1 437 2560