

## DS-1271ZJ-110(Black)

### Pendant Mount



#### Features

- Aluminum alloy with surface spray treatment
- Internal cable routing design
- Apply to indoor conditions, and outdoor conditions

#### Dimension

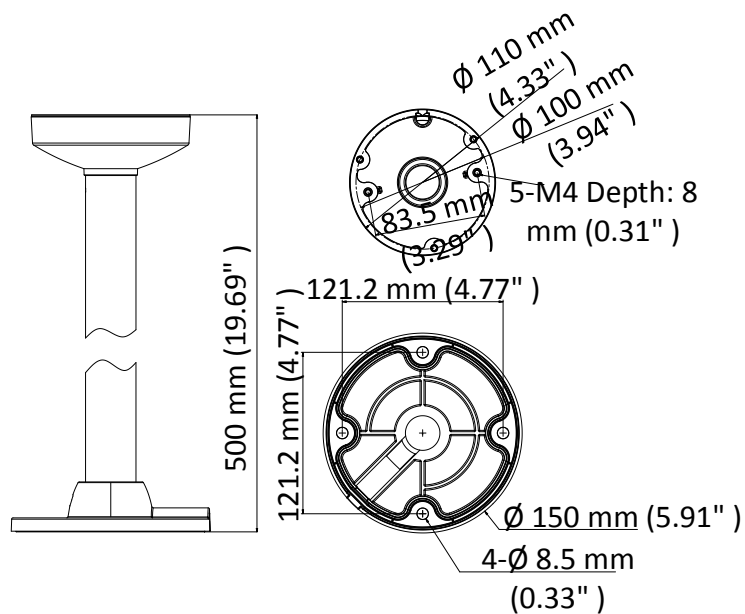

#### Available Model

DS-1271ZJ-110(Black)

#### Parameter

Model	DS-1271ZJ-110(Black)
Parameters	Pendant Mount
Appearance	Black
Material	Aluminum alloy
Dimension	Ø 110 mm × 500 mm × Ø 150 mm (4.33" × 19.69" × 5.91")
Weight	1270 g (2.80 lb.)

#### Notes

- The mount should be installed on the flat surface.
- Waterproof rubber is necessary for outdoor application.
- The wall must be capable of supporting at least 3 times as much as the total weight of the camera, and the mount.
- The maximum load capacity of the mount is 4.5 kg (9.9 lb.).